

SOUNDER 113 dB(A) BExS110 ATEX



- 32 different tones can be set; UK00A/PFEER conform.
- 113 dB(A) sound pressure.
- 3 externally selectable tones – positive and negative control possible in the case of DC devices.
- Quartz-stabilised tone synchronisation.
- Adjustable volume (except 12 V DC).
- ATEX approval.
- Housing made of die-cast aluminium LM6, horn made of ABS.
- Stainless steel mounting bracket for 360° positioning.
- Categories 2G (zones 1 and 2), 2D (zones 21 and 22).

IP 66
IP 67

protection system

+70 °C
-50 °C

operating temperature

EN
54-3

BExS110D
24V DC

VdS
G209081











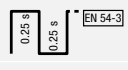

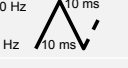



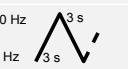

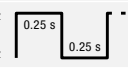

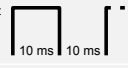
BExS110D
24V DC

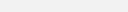
PRODUCT	BExS110				
DATA					
Rated voltage	230 V	115 V	48 V	24 V	12 V
	AC 50 60 Hz		DC		
Operating range	±10 %		±25 %		
Nominal currenconsumption	56 mA	110 mA	130 mA	265 mA	195 mA

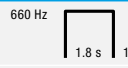
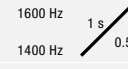
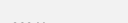
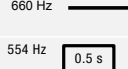
PRODUCT	BExS110	
Type of protection	„D“ = Ex db / Ex tb or „E“ = Ex db / Ex db eb / Ex tb	
Explosion protection	see certificate	
Category (area of use)	2G (Zone 1) / 2D (Zone 21) 3G (Zone 2) / 3D (Zone 22)	
Certificate of conformity	KEMA 99 ATEX 7906 X	
Sound pressure level	113 dB(A)	
Sound pressure level @DIN-tone	112 dB(A)	
Sound level reduction	max. -9 dB(A) (not for 12V DC units)	
Alarm tones	32	
Temperature class T	up to IIC T4 / T100°C @ Ta -50°C...+55°C further details see certificate and installation instruction	
Operating temperature	max. -50°C ... +70°C (see also temperature classes)	
Storage temperature	-50 °C ... +70 °C	
Relative humidity	90 %	
Duty cycle	100 %	
Material	housing	die-cast aluminium LM6, similar to RAL 3000 (flame red)
	horn	ABS self-extinguishing, UL 94 V0 & 5VA FR ABS
Connecting terminals	BExS110D	1x 4 mm ² or 2x 2.5 mm ²
	BExS110E	2x 2.5 mm ²
Cable entry	2 / 1x closed, 1x open (M20), optionally PG13.5 or 1/2" NPT	
Weight	BEXS110D	AC: 3.42 kg DC: 3.16 kg
	BEXS110E	AC: 3.68 kg DC: 3.42 kg

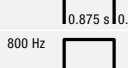
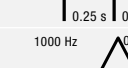
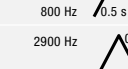
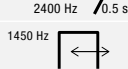
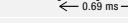
OPTIONS/ACCESSORIES

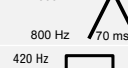
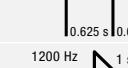
TONE TABLE

No.	Description - basic tone	Stage		No.	Description - basic tone	Stage	
		2	3			2	3
1	Continuous tone	1000 Hz		31	11		
2 ¹	Alternating tone, UK BS5839-1 (fire alarm, railway crossing)	1000 Hz 800 Hz		17	5	EN 54-3	
3	Slow whoop	1200 Hz 500 Hz		2	5		
4	Sweeping (fast)	1000 Hz 800 Hz		6	5		
5	Continuous tone	2400 Hz		3	27		
6	Sweeping	2900 Hz 2400 Hz		7	5		
7	Sweeping (fast)	2900 Hz 2400 Hz		10	5		
8	Sweeping	1200 Hz 500 Hz		2	5		
9	Sawtooth, DIN tone 33404-3 Germany (emergency signal), PFEER PTAP	1200 Hz 500 Hz		15	2	EN 54-3	
10	Alternating tone	2900 Hz 2400 Hz		7	5		
11	Interrupted tone	1000 Hz		31	1		
12	Alternating tone	1000 Hz 800 Hz		4	5		
13	Interrupted tone	2400 Hz		15	5		
14	Interrupted tone	800 Hz		4	5		
15	Continuous tone	800 Hz		2	5		
16	Interrupted tone	660 Hz		18	5	EN 54-3	
17	Alternating tone, France NFS 32-001 (fire alarm)	554 Hz 440 Hz		2	27	EN 54-3	
18	Interrupted tone, Sweden SS031711 (air raid warning)	660 Hz		2	5		
19	Sweeping, France NFC48-265	1600 Hz 1400 Hz		2	5		
20	Continuous tone, Sweden SS031711 (all-clear signal)	660 Hz		2	5		
21	Alternating tone Sweden SS031711	554 Hz 440 Hz		2	5		
22	Interrupted tone	554 Hz		2	5		
23	Interrupted tone	800 Hz		6	5		
24	Sweeping (medium), UK BS5839-1	1000 Hz 800 Hz		29	5		
25	Sweeping	2900 Hz 2400 Hz		29	5		
26	Interrupted tone, (fast variable), bell	1450 Hz		2	1		
27	Continuous tone	554 Hz		26	5		
28	Continuous tone	440 Hz		2	5		
29	Sweeping (fast), UK BS5839-1	1000 Hz 800 Hz		7	5		
30	Interrupted tone, Australia AS2220, AS1610, AS1670	420 Hz		32	5		
31	Sawtooth, DIN tone 33404-3 Germany (emergency signal)	1200 Hz 500 Hz		11	1		
32	Slow whoop, Australian evacuation alarm AS2220	1200 Hz 500 Hz		26	1		

¹ factory setting

The Sounder can be set externally to the respective tones of a stage 2 & 3. Tone 2 is preset.

ARTICLE NO.	BExS110D		BExS110E		
	Rated voltage	230 V AC	24 V DC	230 V AC	24 V DC
	32080100000	32080800000	32082100000	32082800000	

DIMENSIONS

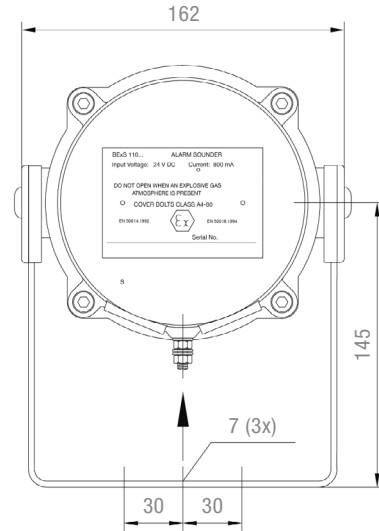
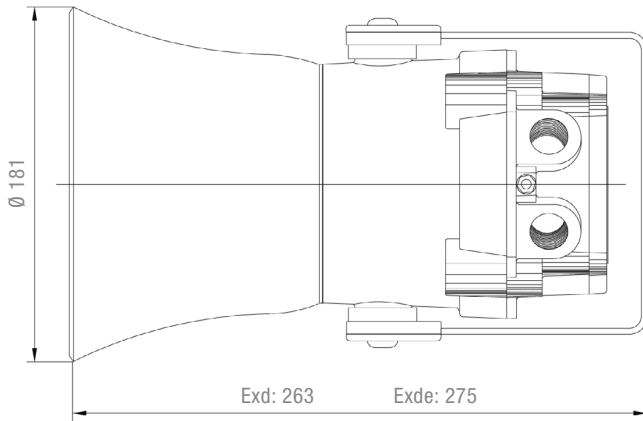

CONNECTION DIAGRAMS

AC

DC

